

Features

- Patented K-joint installation ensures consistent trim appearance, regardless of variability in valve rough-in
- Ergonomic lever handle is ADA-compliant
- Trim requires valve to complete
- KOHLER finishes resist corrosion and tarnishing, exceeding industry durability standards over two times

Required Accessories

K-2972-KS 1/2" Thermostatic Mixing Valve

or

K-2975-KS 3/4" Thermostatic Mixing Valve



ADA

Codes/Standards

ASME A112.18.1/CSA B125.1

ADA







ICC/ANSI A117.1

Kohler Faucet Lifetime Limited Warranty

See website for detailed warranty information.

Available Color/Finishes

Color tiles intended for reference only.

Color	Code	Description
	CP	Polished Chrome
	SN	Vibrant® Polished Nickel
	PB	Vibrant® Polished Brass
	BN	Vibrant® Brushed Nickel
	BV	Vibrant® Brushed Bronze
	2BZ	Oil-Rubbed Bronze

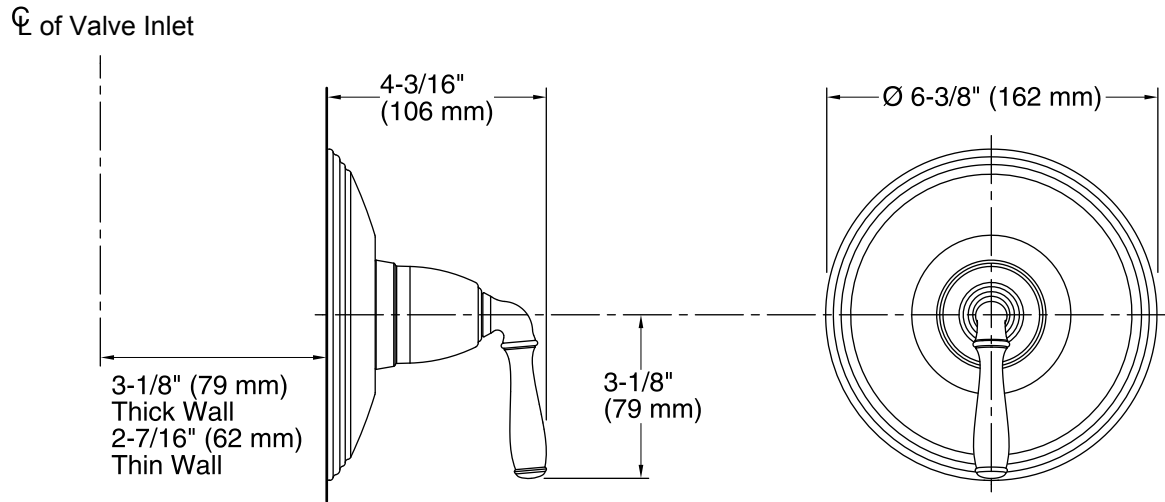

Technical Information

All product dimensions are nominal.

Notes

ADA compliant when installed to the specific requirements of these regulations.