

MIRRORED CABINET K-99002

Features

- Rust-free anodized aluminum cabinet box and door
- For recessed or surface-mount installation
- Reversible left-hand or right-hand door hinge option
- Side mirror kit sold separately
- Three adjustable glass shelves
- 108° self-close hinges
- Triple-mirror design - front of door, back of door, and interior back of cabinet
- Hang-and-secure mounting system for easier surface-mount installation
- 20" (508 mm) width x 30" (762 mm) height x 4-3/4" (121 mm) depth

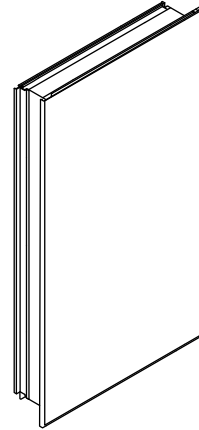

Codes/Standards Applicable

Specified model meets or exceeds the following:

- None applicable

Colors/Finishes

- NA: None applicable

Accessories

- NA: None applicable

Specified Model

Model	Description	Colors/Finishes
K-99002	Mirrored cabinet	<input type="checkbox"/> NA
Optional Accessories		
K-99012	Side mirror kit for surface-mount installation	<input type="checkbox"/> NA

Product Specification

The mirrored cabinet shall be 20" (508 mm) in width, 30" (762 mm) in height, and 4-3/4" (121 mm) in depth. Cabinet shall have a rust-free anodized aluminum cabinet box and door. Cabinet shall be for recessed or surface-mount installation. Cabinet shall feature hang-and-secure mounting system for easier surface-mount installation. Cabinet shall feature a triple-mirror design with a mirror on the front of door, back of door, and interior back of cabinet. Cabinet shall include three adjustable glass shelves. Side mirror kit shall be sold separately. Cabinet shall feature a reversible left-hand or right-hand door hinge option with 108° self-close hinges. Mirrored cabinet shall be Kohler model K-99002-NA.

VERDERA™

Technical Information

Cutout for recess-mount installations:

18-1/2" (470 mm) width x 28-1/4" (718 mm) height x
3-11/16" (94 mm) depth

Installation Notes

Install this product according to the installation guide.



CAUTION: Risk of electric shock. Electrical wiring may need to be relocated.

IMPORTANT! For recess mounting, the wall cavity must be framed and cabinet secured to framing studs. Reroute any electrical wires or water supply piping from the wall cavity. If you encounter drain or vent piping, or if your wall is load-bearing, consult a professional before proceeding.



CAUTION: Risk of property damage. For surface mounting, use anchors (not provided) rated for the loaded weight of this product. Refer to the anchor manufacturer's instructions.

When determining the height of the cabinet, ensure the mirrored door will clear all obstacles (such as a faucet). A minimum distance of 3" (76 mm) is required.

This cabinet is designed for either right or left door swing. Check for obstructions.

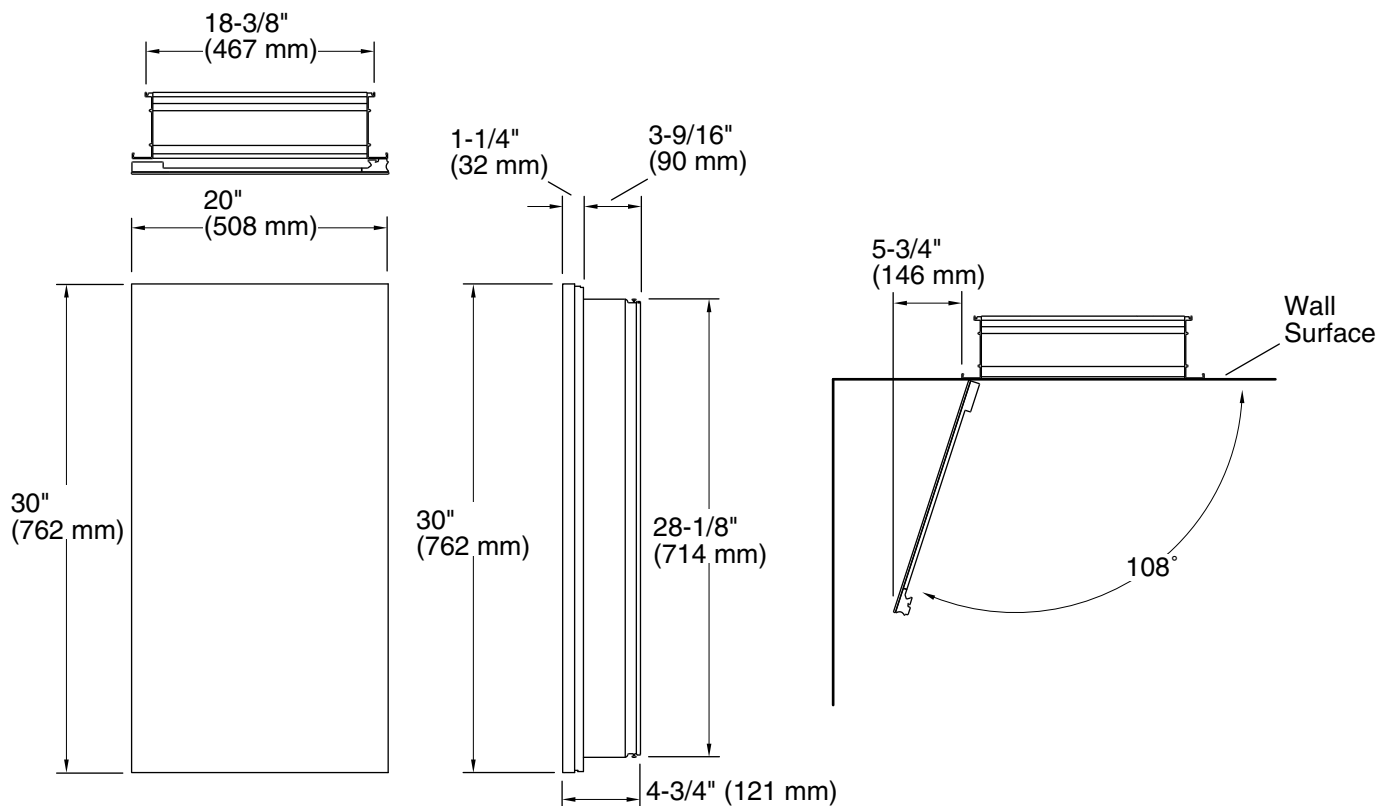

Product Diagram