

Features

- Solid-brass construction for durability.
- Left-hand trip lever.
- KOHLER finishes resist corrosion and tarnish.
- For use with Adair one-piece and Cimarron one- and two-piece toilets.



ADA

Codes/Standards











ADA
ICC/ANSI A117.1

KOHLER® One-Year Limited Warranty

See website for detailed warranty information.

Available Color/Finishes

Color tiles intended for reference only.

Color	Code	Description
	SN	Vibrant® Polished Nickel
	AF	Vibrant® French Gold
	PB	Vibrant® Polished Brass
	BGD	Vibrant® Moderne Brushed Gold
	G	Brushed Chrome
	BN	Vibrant® Brushed Nickel
	BV	Vibrant® Brushed Bronze
	2BZ	Oil-Rubbed Bronze
	TT	Titanium
	VNT	Vintage Nickel

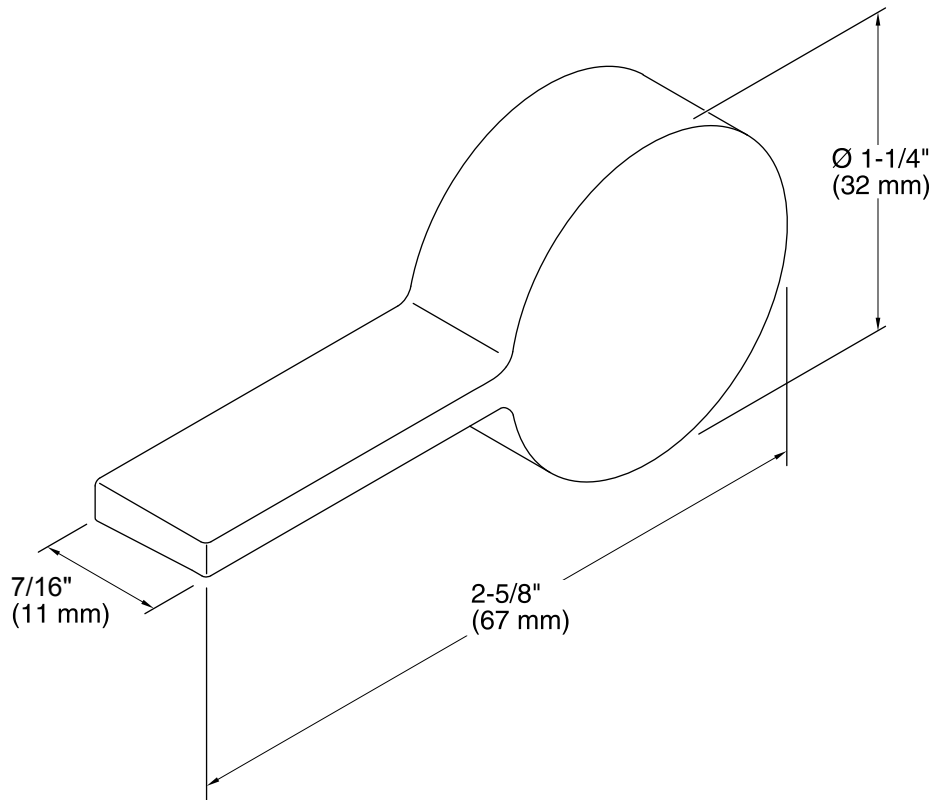

Technical Information

All product dimensions are nominal.

Notes

ADA compliant when installed to the specific requirements of these regulations.