

Features

- For use with the K-5409 Strive kitchen sink.
- Helps protect sink surface from daily wear.
- Dishwasher safe.
- Rubber feet provide added protection.

Material

- Durable stainless-steel construction.

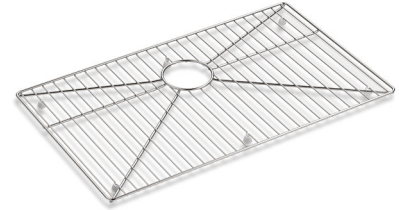

Codes/Standards

None Applicable

KOHLER® One-Year Limited Warranty

See website for detailed warranty information.

Available Color/Finishes

Color tiles intended for reference only.

Color	Code	Description
	ST	Stainless Steel

KOHLER®

Strive®
Stainless Steel Sink Rack
K-5408

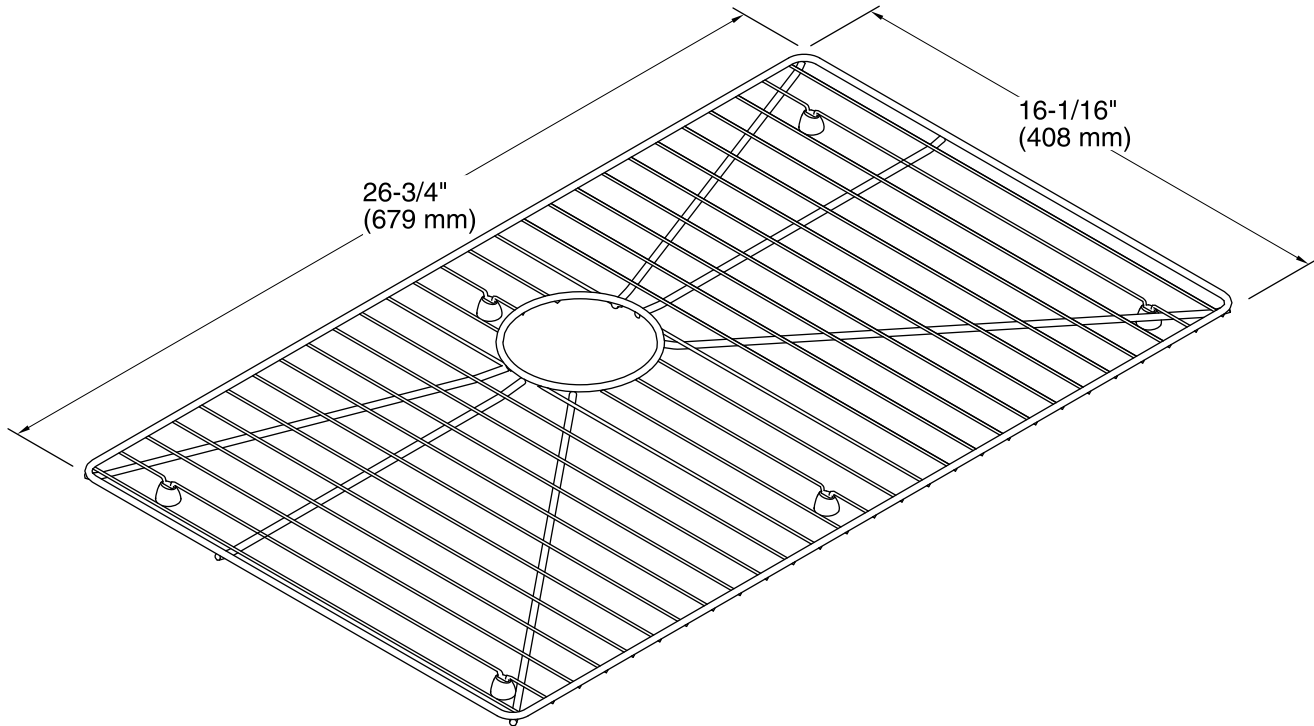
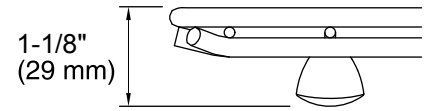

Technical Information

All product dimensions are nominal.

USA/Canada: 1-800-4KOHLER (1-800-456-4537)

Kohler Co. reserves the right to make revisions without notice to product specifications.

For the most current Specification Sheet, go to www.kohler.com.

8-15-2016 03:42

THE BOLD LOOK
OF **KOHLER®**