

Features

- Vitreous china.
- Elongated bowl.
- Class Five® flushing system.
- One-piece.
- Includes seat and cover.
- Less supply.
- 12" (305 mm) rough-in.
- 1.28 gallons per flush (gpf).
- 2-1/8" (54 mm) glazed trapway.
- Polished chrome trip lever.
- 11" (279 mm) x 7-3/4" (197 mm) water area.
- 28-9/16" (725 mm) x 16-5/16" (414 mm) x 28-7/16" (722 mm).

Recommended Accessories

- K-4650 Toilet Seat
- K-7637 Angle Supply with Stop (single)

Optional Accessories

- K-9466-L Left-hand Trip Lever

Components

Product includes:

- K-4636 Toilet Seat
- Additional included component/s: Tank cover, Trip lever, Bolt cap accessory pack, and Tank accessory pack.



ADA CSA B651 OBC

Codes/Standards











ASME A112.19.2/CSA B45.1
DOE - Energy Policy Act 1992
EPA WaterSense®
ADA
ICC/ANSI A117.1
CSA B651
OBC

KOHLER® One-Year Limited Warranty

See website for detailed warranty information.

Available Color/Finishes

Color tiles intended for reference only.

Color	Code	Description
	0	White
	96	Biscuit
	47	Almond
	NY	Dune
	95	Ice™ Grey
	G9	Sandbar
	33	Mexican Sand™
	K4	Cashmere
	58	Thunder™ Grey
	7	Black Black™

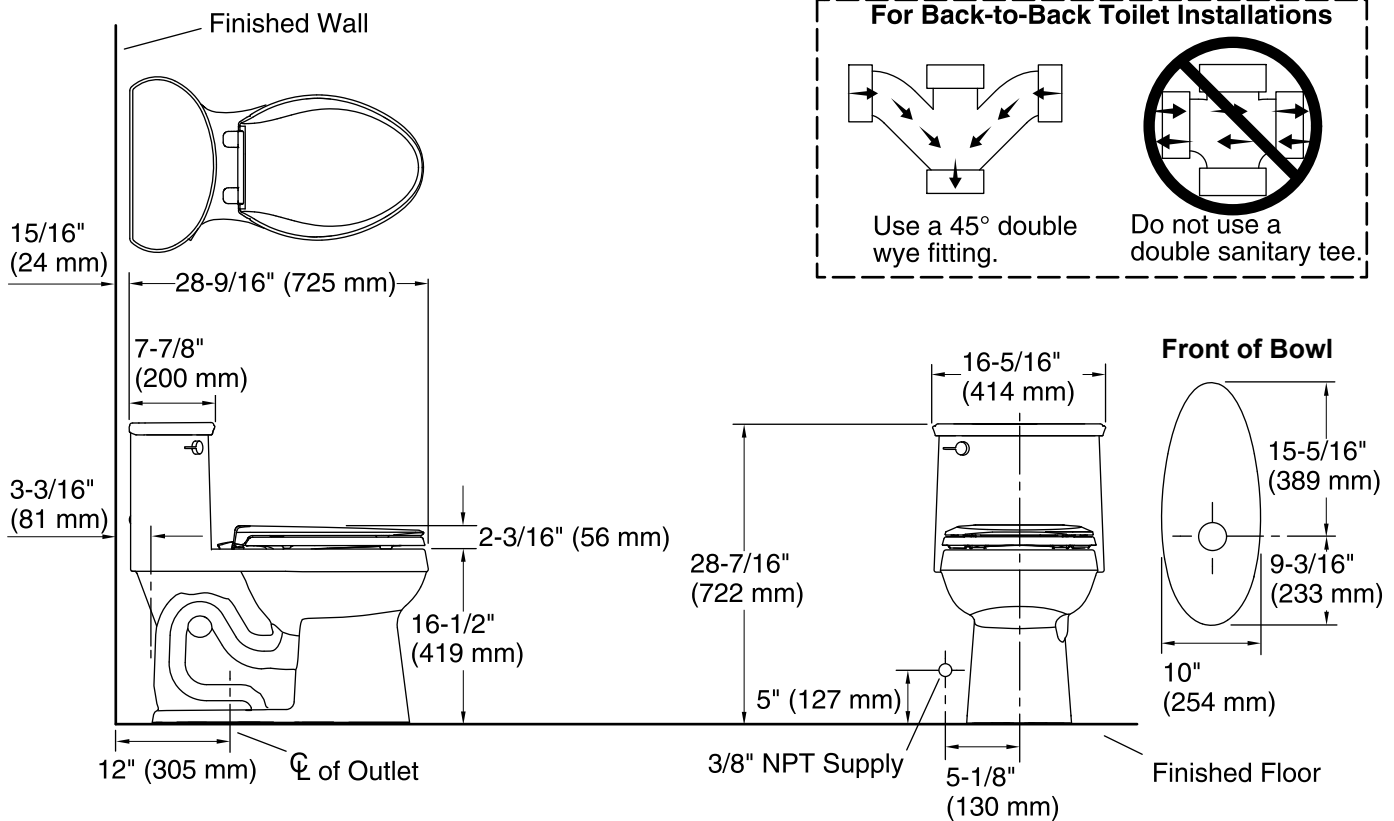

Technical Information

All product dimensions are nominal.

Toilet type:	One-piece
Bowl shape:	Elongated front
Flush type:	AquaPiston
Seat hinge type:	Quick-Attach®, Quiet-Close™, Quick-Release™
Trap passageway:	2-1/8" (54 mm)
Water Consumption	
Full:	1.28 gpf (4.8 lpf)
Water surface size:	11" x 7-3/4" (279 mm x 197 mm)
Rim to water surface:	6-1/16" (154 mm)
Rough-in:	12" (305 mm)
Seat-mounting holes:	5-1/2" (140 mm)

Notes

Install this product according to the installation guide.

ADA, OBC, CSA B651 compliant when installed to the specific requirements of these regulations.

The Model Plumbing Codes require the installation of elongated open-front toilet seats on public bathrooms.