

### Features

- One-piece toilets integrate the tank and bowl into a seamless, easy-to-clean design.
- Elongated bowl offers added room and comfort.
- Comfort Height® feature offers chair-height seating that makes sitting down and standing up easier for most adults.
- 1.28 gallons per flush (gpf).
- Concealed trapway facilitates easy cleaning and enhances design.
- Standard left-hand Polished Chrome trip lever included.
- Grip-Tight Glenbury Quiet-Close™ seat with Quick-Release™ functionality allows seat to close quietly and quickly unlatch from the toilet for easy removal and convenient cleaning.
- Supply line not included.
- Coordinates with other products in the Kathryn collection.

### Technology

- Single-flush gravity uses the force of gravity and a precision-engineered tank to create a strong siphon during flushing.
- AquaPiston canister allows water to flow into the bowl from all sides (360 degrees), increasing the power and effectiveness of the flush.
- Flush valve's 3:2 ratio harnesses the natural force of gravity and optimizes flush performance.
- Durable canister design has 90% less exposed seal material than a 3-inch flapper, for leak-free performance.
- Light-touch canister flush requires a lower actuation force than a flapper.

### Installation

- Standard 12-inch rough-in.

### Recommended Accessories

K-7637 Angle Supply with Stop (single)

### Optional Accessories

K-9131 Trip Lever  
K-4650 Toilet Seat

### Components

Product includes:

K-4733 Toilet Seat

Additional included component/s: Tank cover, trip lever, tank accessory pack, and bolt cap accessory pack.



**ADA** **CSA B651** **OBC**

### Codes/Standards











ASME A112.19.2/CSA B45.1  
EPA WaterSense®  
ADA  
ICC/ANSI A117.1  
CSA B651  
OBC

### Kohler One-Year Limited Warranty

See website for detailed warranty information.

### Available Color/Finishes

*Color tiles intended for reference only.*

Color	Code	Description
	0	White
	96	Biscuit
	47	Almond
	NY	Dune
	95	Ice™ Grey
	G9	Sandbar
	33	Mexican Sand™
	K4	Cashmere
	58	Thunder™ Grey
	7	Black Black™

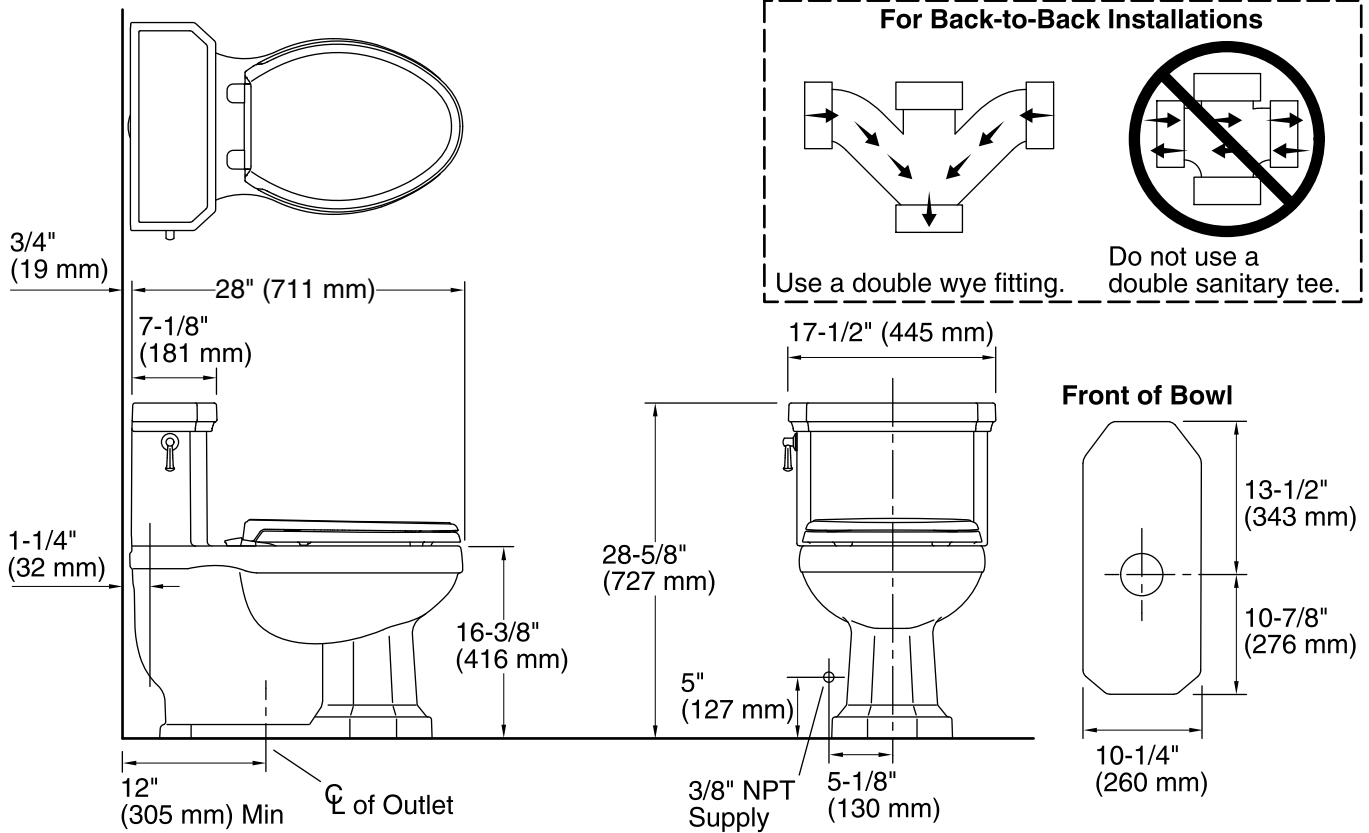

## Technical Information

All product dimensions are nominal.

Toilet type:	One-piece
Bowl shape:	Elongated front
Trap passageway:	2-1/8" (54 mm)
Water Consumption	
Full:	1.28 gpf (4.8 lpf)
Water surface size:	10-1/2" x 7-1/2" (267 mm x 191 mm)
Rim to water surface:	5-5/8" (143 mm)
Rough-in:	12" (305 mm)
Seat-mounting holes:	5-1/2" (140 mm)

## Notes

Install this product according to the installation instructions.

Will comply with the Americans with Disabilities (ADA) when installed per requirements of the 2010 ADA Standards for Accessible Design, Section 604 Water Closets, of the Act. The Model Plumbing codes require the installation of elongated open-front toilet seats in public bathrooms.

Will comply with CSA B651 when installed per Clause 4.3.6 of the standard.

Will comply with OBC Barrier Free requirements when installed per Clause 3.8.3.8 and 3.8.3.9.

ADA, OBC, CSA B651 compliant when installed to the specific requirements of these regulations.

The Model Plumbing Codes require the installation of elongated open-front toilet seats on public bathrooms.