







Features

- Brass construction
- Traditional styling
- Complements Revival® faucet line

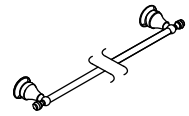
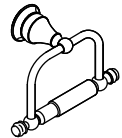
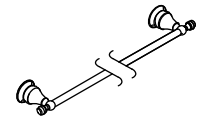
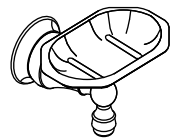
Colors/Finishes

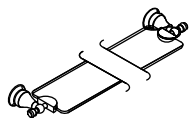
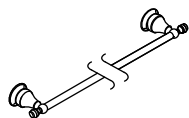
- CP: Polished Chrome
- PB: Vibrant® Polished Brass
- Other: Refer to Price Book for additional colors/finishes

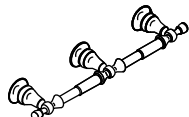
Specified Model

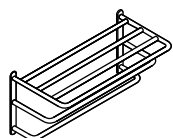
Model/Description		Model/Description	
K-16140 Towel ring <input type="checkbox"/> CP <input type="checkbox"/> PB <input type="checkbox"/> Other_____		K-16147 30" (762 mm) towel bar <input type="checkbox"/> CP <input type="checkbox"/> PB <input type="checkbox"/> Other_____	
K-16141 Toilet tissue holder <input type="checkbox"/> CP <input type="checkbox"/> PB <input type="checkbox"/> Other_____		K-16148 18" (457 mm) towel bar <input type="checkbox"/> CP <input type="checkbox"/> PB <input type="checkbox"/> Other_____	
K-16142 Soap dish <input type="checkbox"/> CP <input type="checkbox"/> PB <input type="checkbox"/> Other_____		K-16149 Tumbler and toothbrush holder, includes glass tumbler <input type="checkbox"/> CP <input type="checkbox"/> PB <input type="checkbox"/> Other_____	
K-16143 Glass shelf <input type="checkbox"/> CP <input type="checkbox"/> PB <input type="checkbox"/> Other_____		K-16150 24" (610 mm) towel bar <input type="checkbox"/> CP <input type="checkbox"/> PB <input type="checkbox"/> Other_____	
K-16145 Oval mirror, includes pivot mounting brackets <input type="checkbox"/> CP <input type="checkbox"/> PB <input type="checkbox"/> Other_____		K-16152 Revival 14" (356 mm) double toilet tissue holder <input type="checkbox"/> CP <input type="checkbox"/> PB <input type="checkbox"/> Other_____	
K-16146 Robe hook <input type="checkbox"/> CP <input type="checkbox"/> PB <input type="checkbox"/> Other_____		K-16155 Towel shelf <input type="checkbox"/> CP <input type="checkbox"/> PB	

Product Specification

The accessories shall be made of brass construction. Accessories shall have traditional styling. Accessories shall complement Revival faucet line. Accessories shall be Kohler Model K-____-____.

REVIVAL®

Installation Notes

Install this product according to the installation guide.

Model/Description	
K-16156 12" (305 mm) grab bar <input type="checkbox"/> CP <input type="checkbox"/> PB <input type="checkbox"/> Other_____	
K-16158 18" (457 mm) grab bar <input type="checkbox"/> CP <input type="checkbox"/> PB	
K-16295 Knob cabinet hardware <input type="checkbox"/> CP <input type="checkbox"/> PB <input type="checkbox"/> Other_____	
K-16296 Pull cabinet hardware <input type="checkbox"/> CP <input type="checkbox"/> PB <input type="checkbox"/> Other_____	

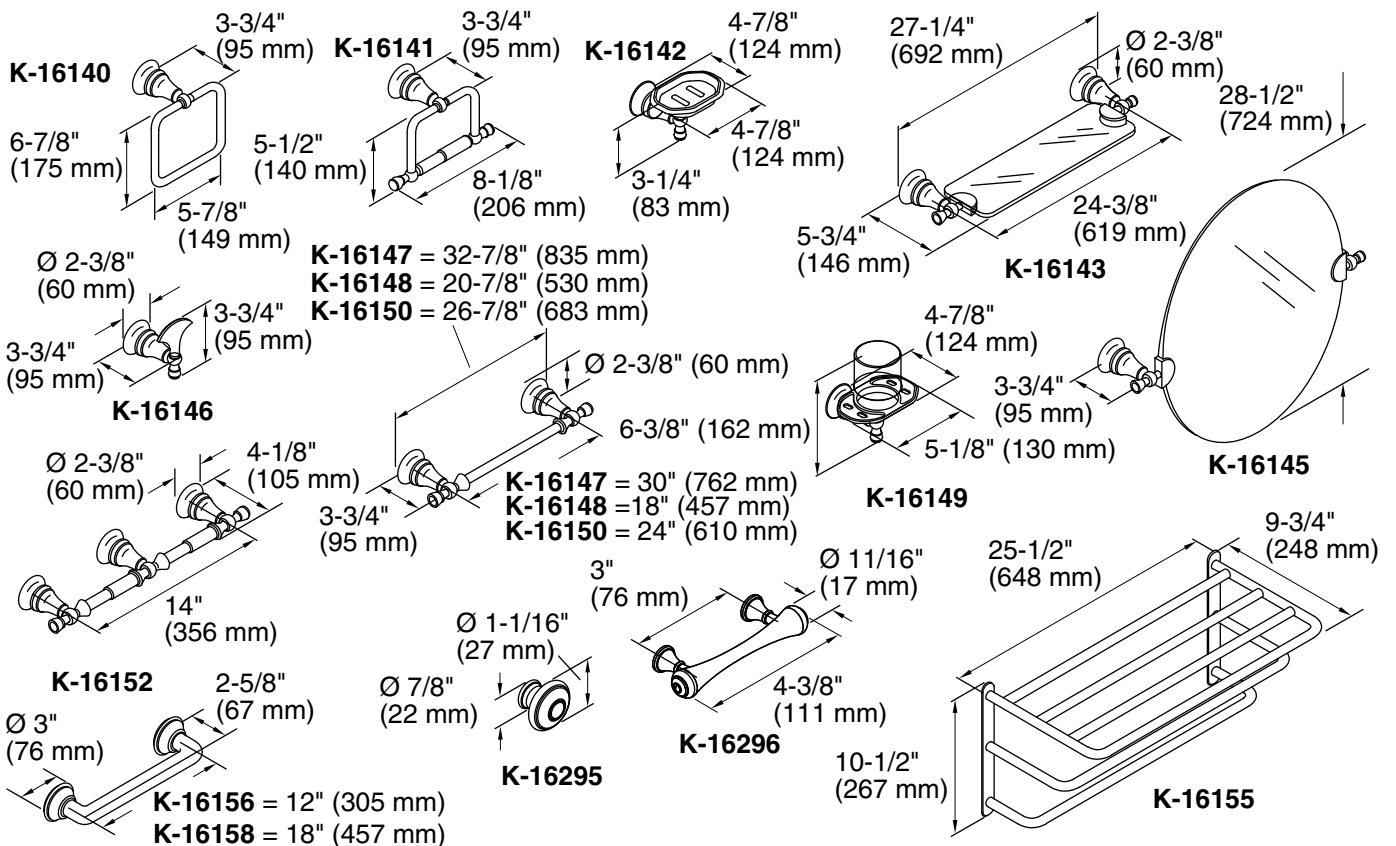

Product Diagram