

#### Features

- Premium metal construction for durability.
- KOHLER finishes resist corrosion and tarnish.
- For use with Archer one- and two-piece toilets.
- Coordinates with other products in the Archer Collection.



ADA

CSA B651

OBC

#### Codes/Standards

ASME A112.18.1/CSA B125.1

ADA

ICC/ANSI A117.1

CSA B651







OBC

#### KOHLER® One-Year Limited Warranty

See website for detailed warranty information.

#### Available Color/Finishes

*Color tiles intended for reference only.*

Color	Code	Description
	SN	Vibrant® Polished Nickel
	AF	Vibrant® French Gold
	PB	Vibrant® Polished Brass
	G	Brushed Chrome
	BN	Vibrant® Brushed Nickel
	BV	Vibrant® Brushed Bronze
	2BZ	Oil-Rubbed Bronze

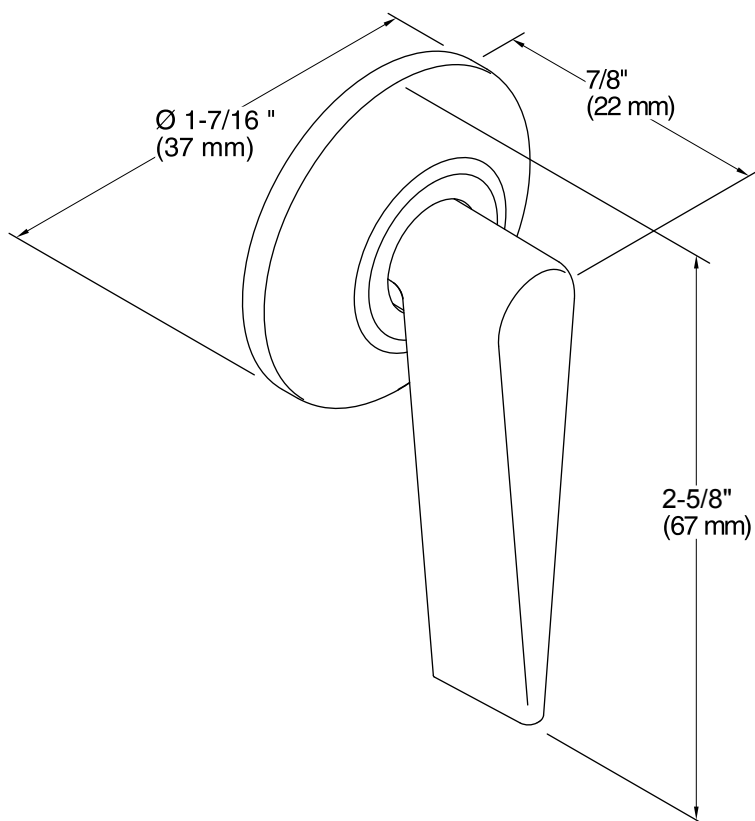

#### Technical Information

All product dimensions are nominal.

#### Notes

ADA, OBC, CSA B651 compliant when installed to the specific requirements of these regulations.